

27127  
B 14 1

58P

# V. R. MAROONA NEW STATION ISLAND PLATFORM VERANDAHS

CONTRACT NO. 29625.

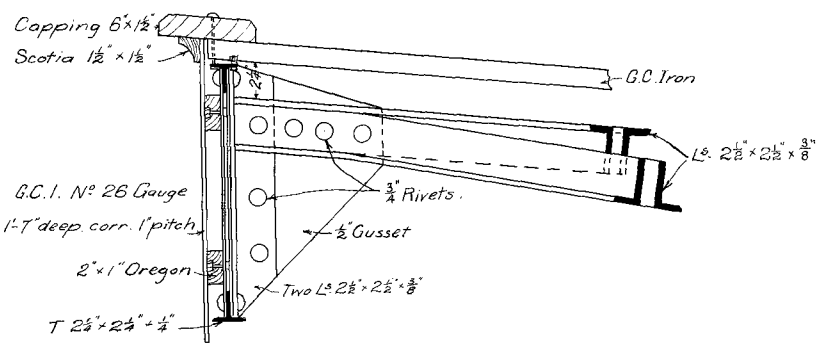

End of Principal  
Scale 1/2" = 1'-0"

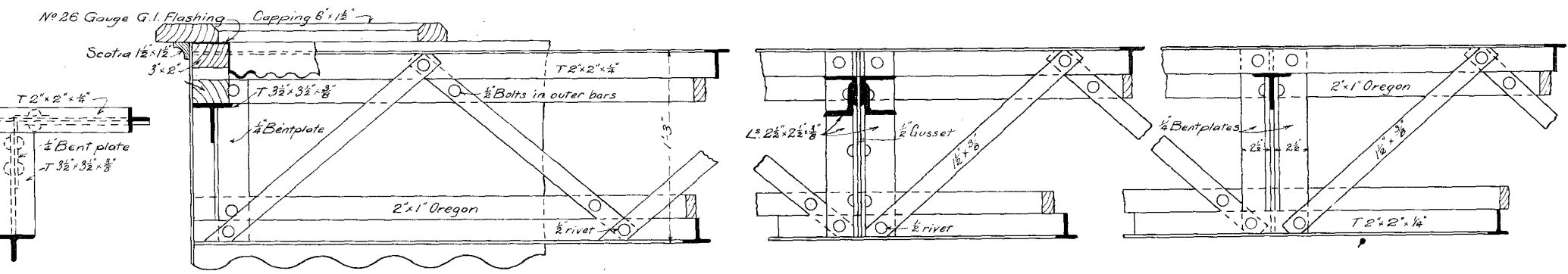

Detail of Girder & Screen  
Scale 1/2" = 1'-0"

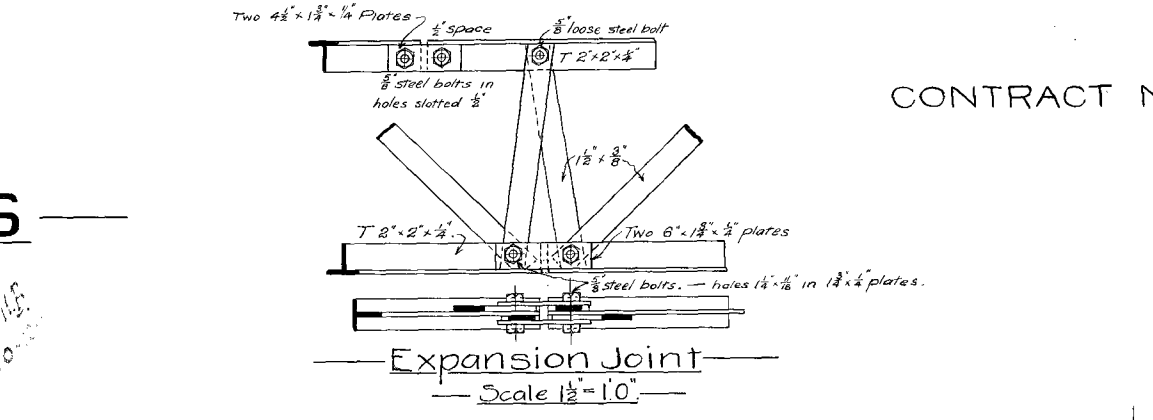

Expansion Joint  
Scale 1/2" = 1'-0"

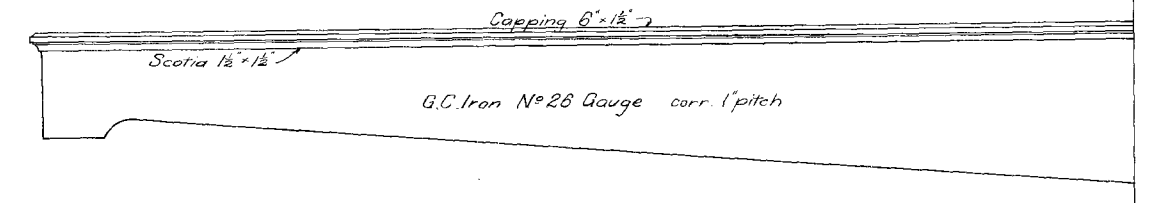

End Elevation  
Scale 1/2" = 1'-0"

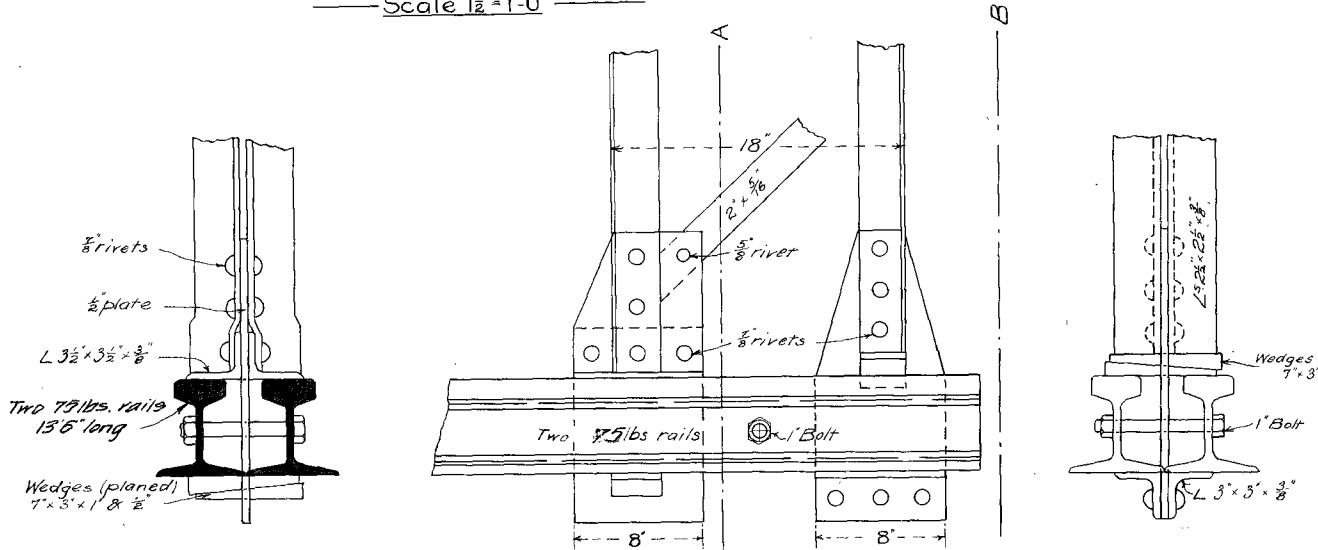

AtAA

Details of Principal  
Scale 1/2" = 1'-0"

AtBB

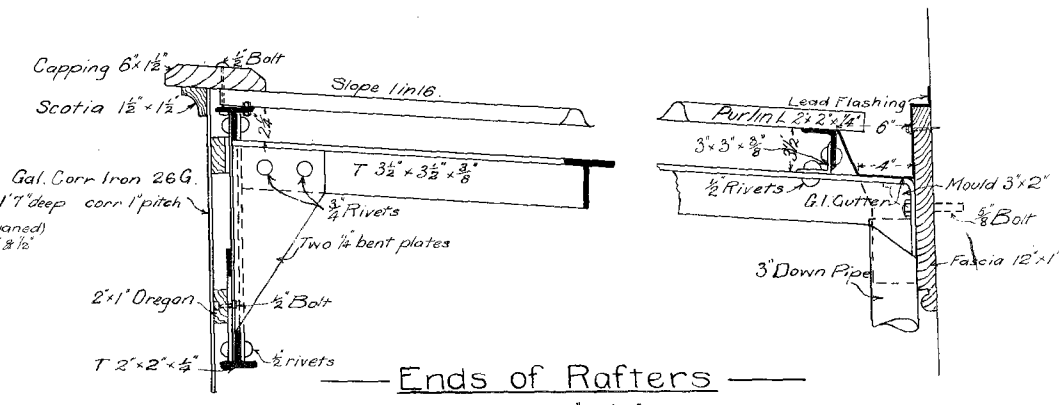

Ends of Rafters  
Scale 1/2" = 1'-0"

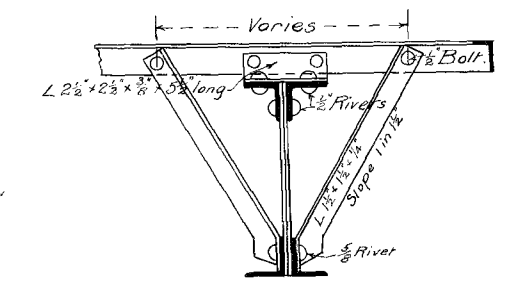

Stiffener to Purlin  
Scale 1/2" = 1'-0"

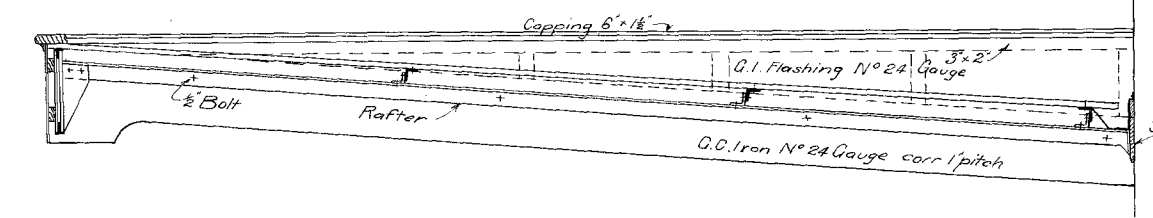

End Rafter  
Scale 1/2" = 1'-0"

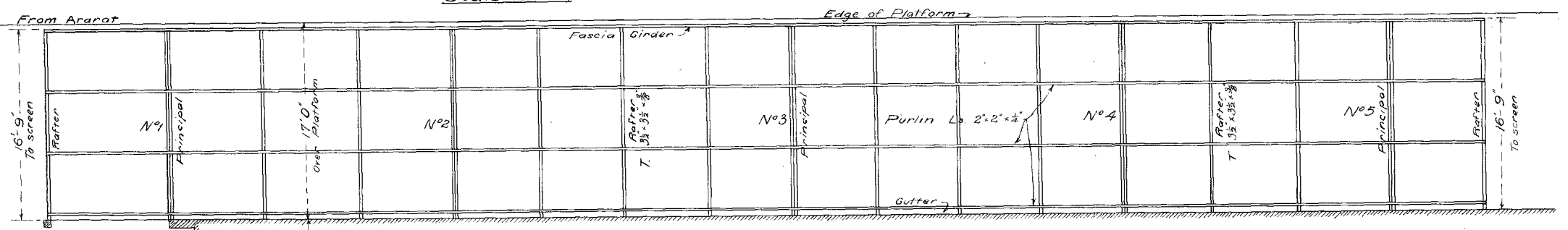

Station Buildings

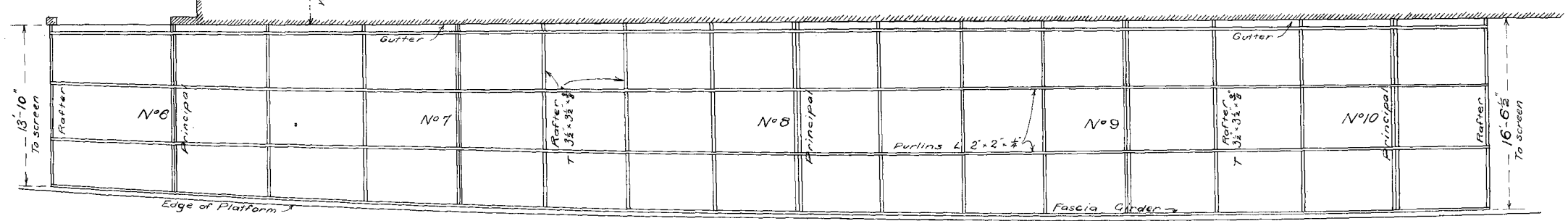

Plan  
Scale 1/2" = 1'-0"

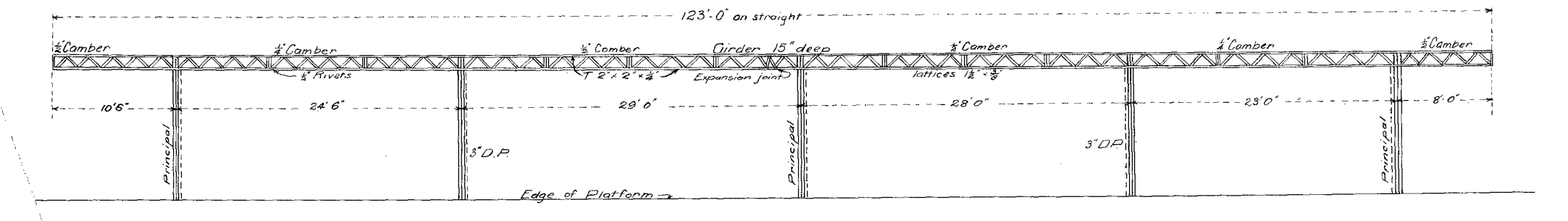

Elevation  
Scale 1/2" = 1'-0"

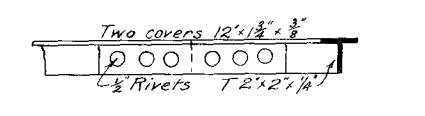

Joint in Girder  
Scale 1/2" = 1'-0"

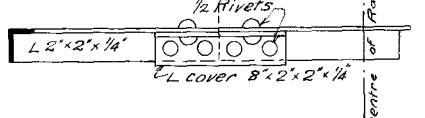

Joint in Purlin  
Scale 1/2" = 1'-0"

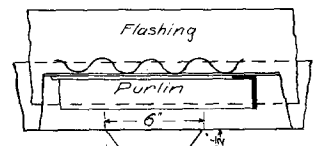
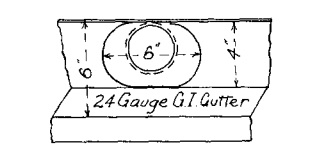

Hopper End of Downpipe  
Scale 1/2" = 1'-0"

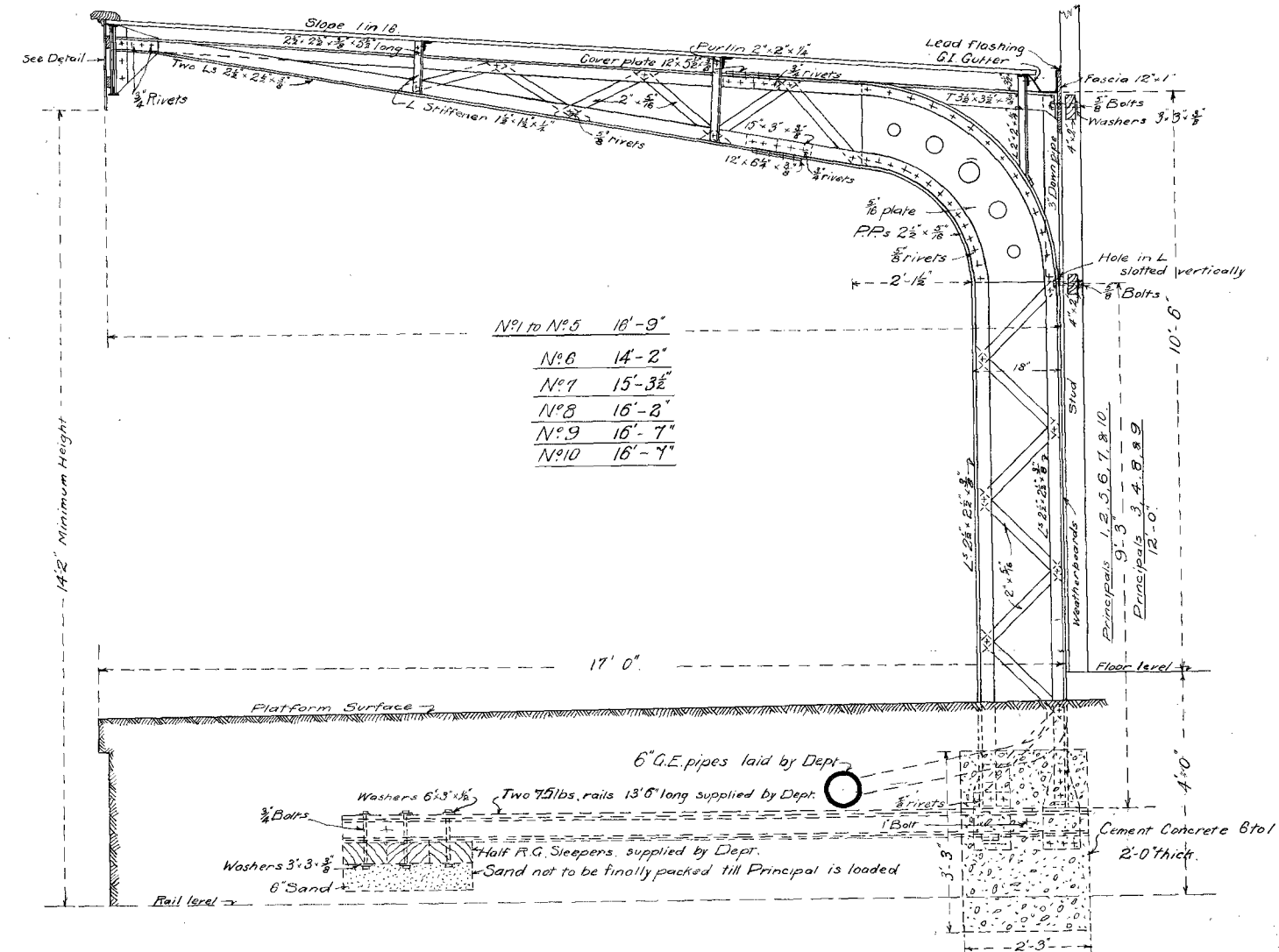

Principal  
Scale 1/2" = 1'-0"

A 17 54